

CREATE  
YOUR STYLE with  
CRYSTALLIZED™  
– Swarovski Elements



MAKE YOUR CREATIVITY STICK

VASE  
SPARKLING  
MEADOW

# VASE SPARKLING MEADOW



## CRYSTALLIZED™ – Swarovski Elements

## Supplies & Tools

Article	Product Group	Article No.	Amount	Size	Colour	Colour Code
	Flat Backs No Hotfix	2028	15 pcs.	SS20	Jonquil	213
	Flat Backs No Hotfix	2028	5 pcs.	SS20	Light Topaz	226
	Flat Backs No Hotfix	2028	5 pcs.	SS34	Jonquil	213
	Flat Backs No Hotfix	2028	7 pcs.	SS34	Light Topaz	226
	Flat Backs No Hotfix	2400	41 pcs.	3 mm	Crystal	001
	Flat Backs No Hotfix	2709	13 pcs.	10x6 mm	Crystal	001

### Supplies

Paper, white, A4  
Porcelain vase, yellow, 17 x ø 9/7 cm

### Tools

Compass, Cutter, Glue, Pencil,  
Punching pliers, Ruler, Tape, Tweezers,  
Wire

Level of Design: BEGINNER

Have a look at the **text instruction** at the last page!

## STEP 1

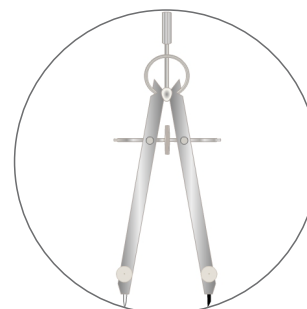
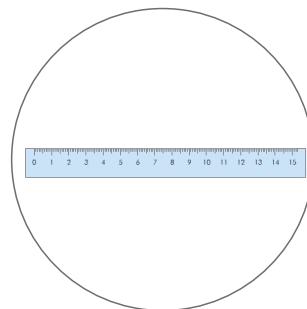
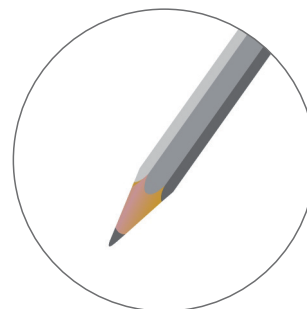
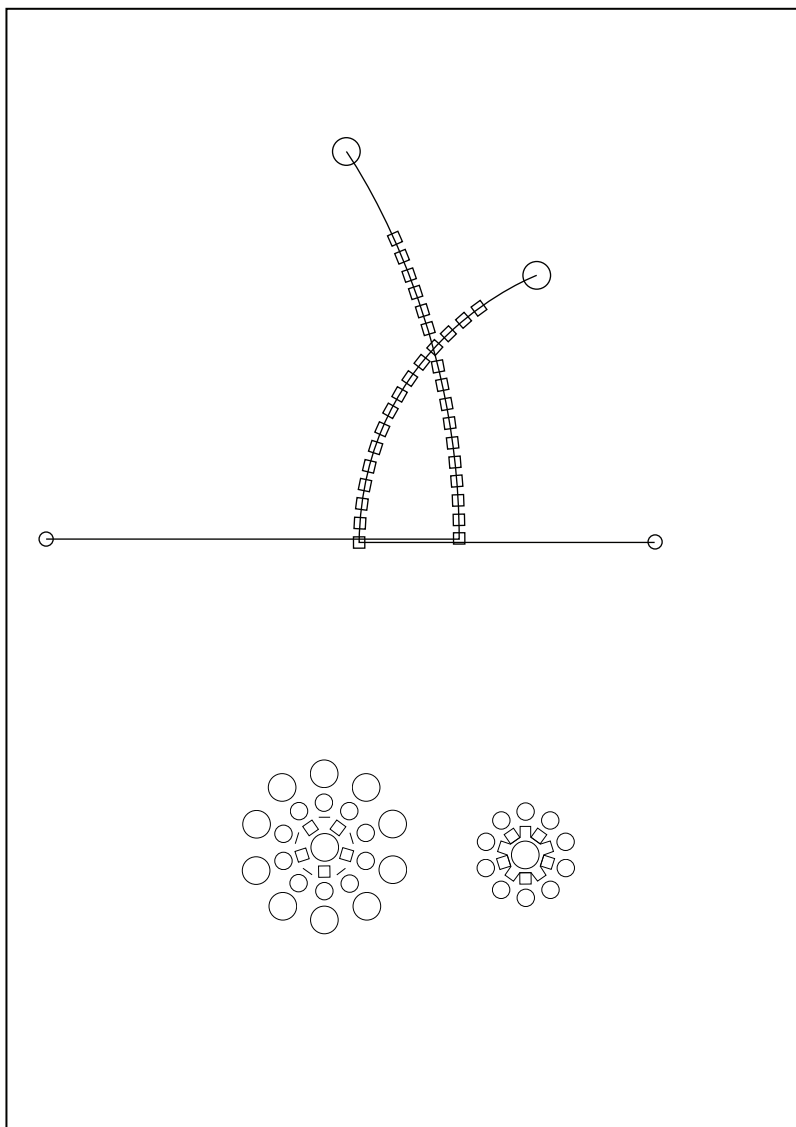

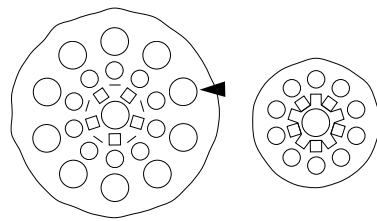
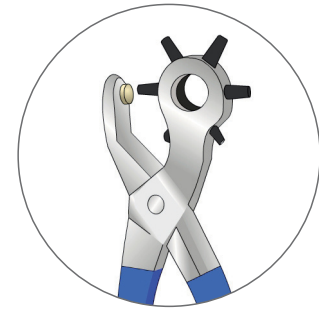
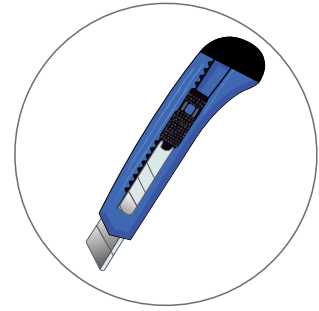
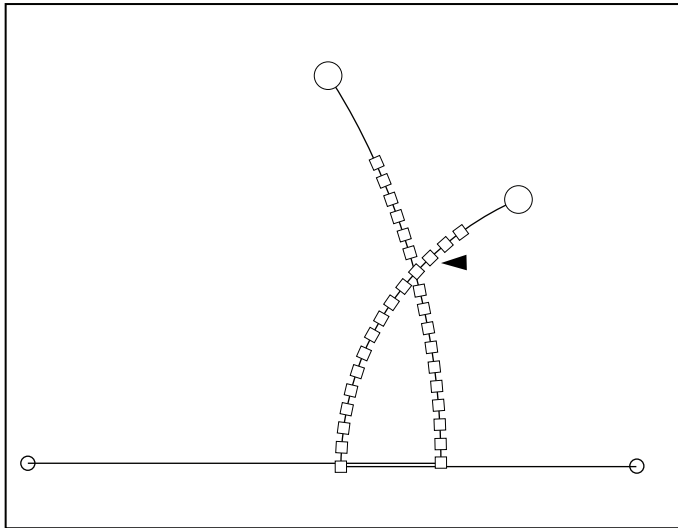

STEP 2

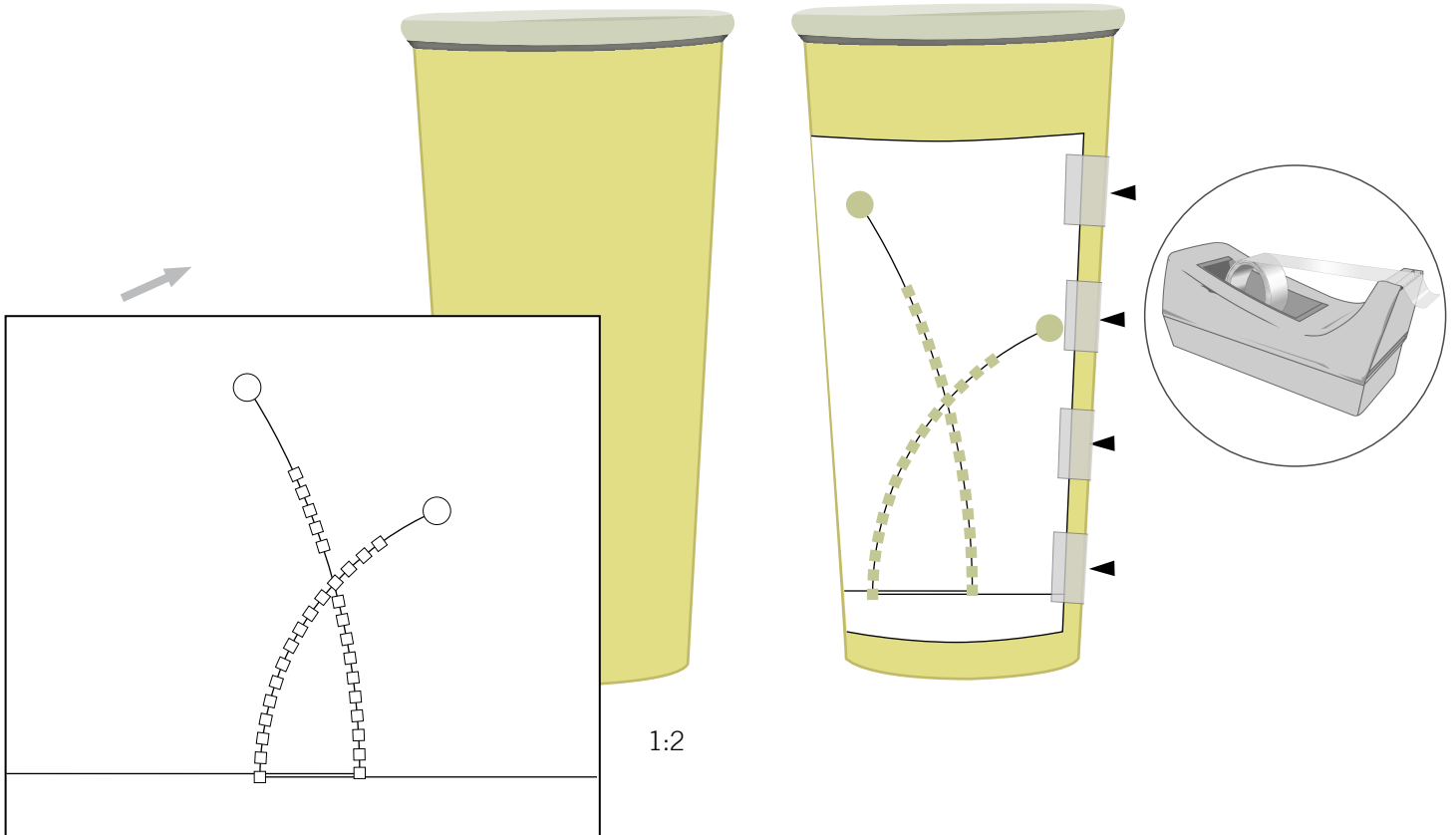

STEP 3

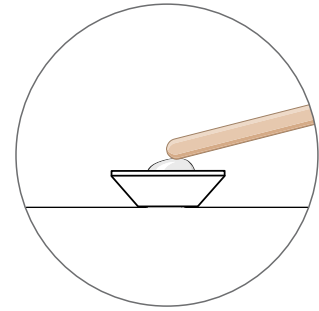
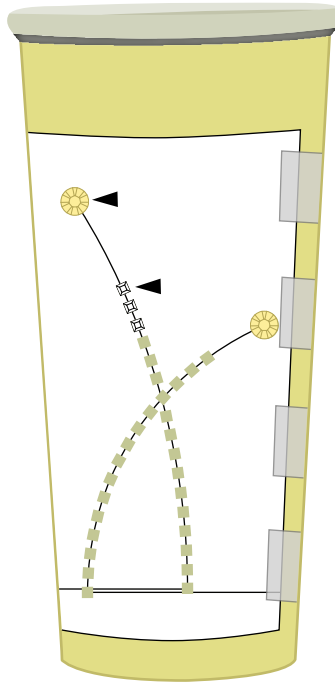

Repeat x30

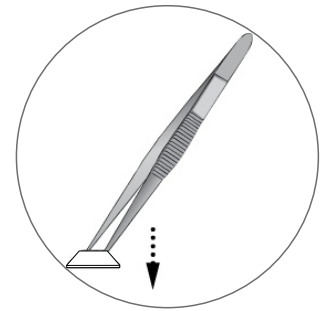
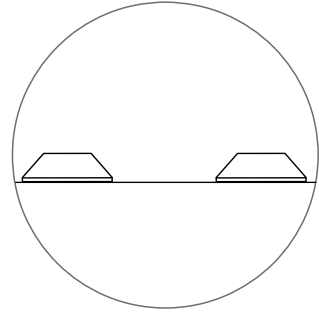

STEP 4

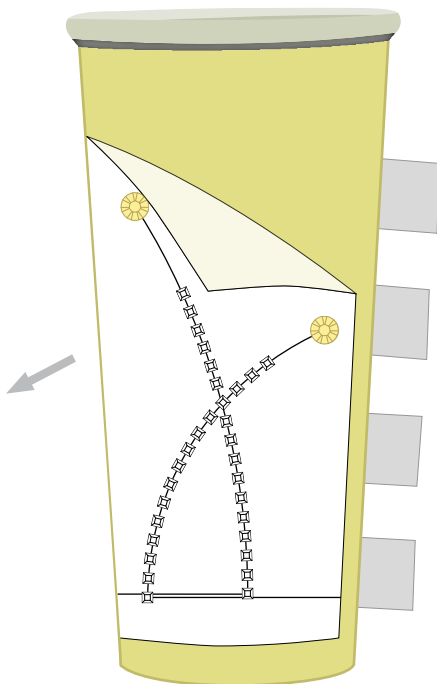

STEP 5

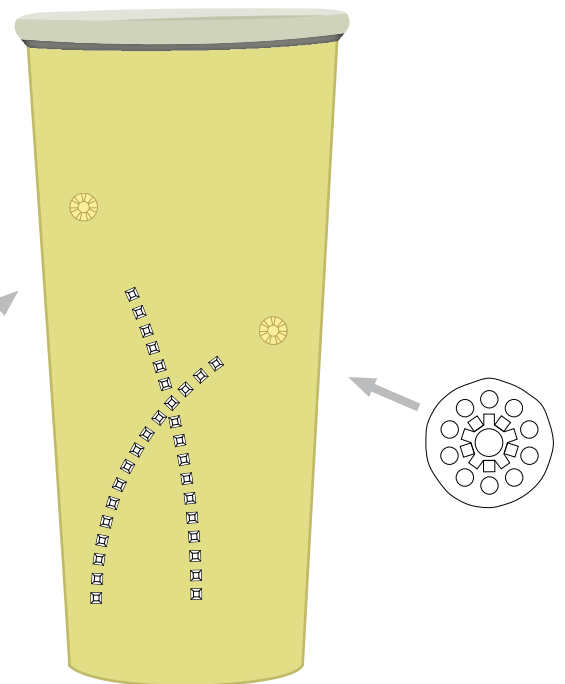
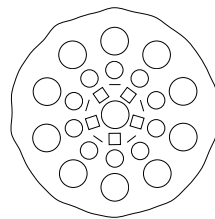

STEP 6

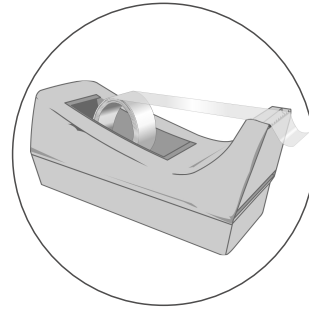
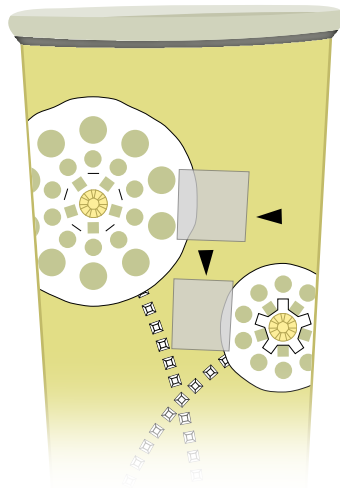

STEP 7

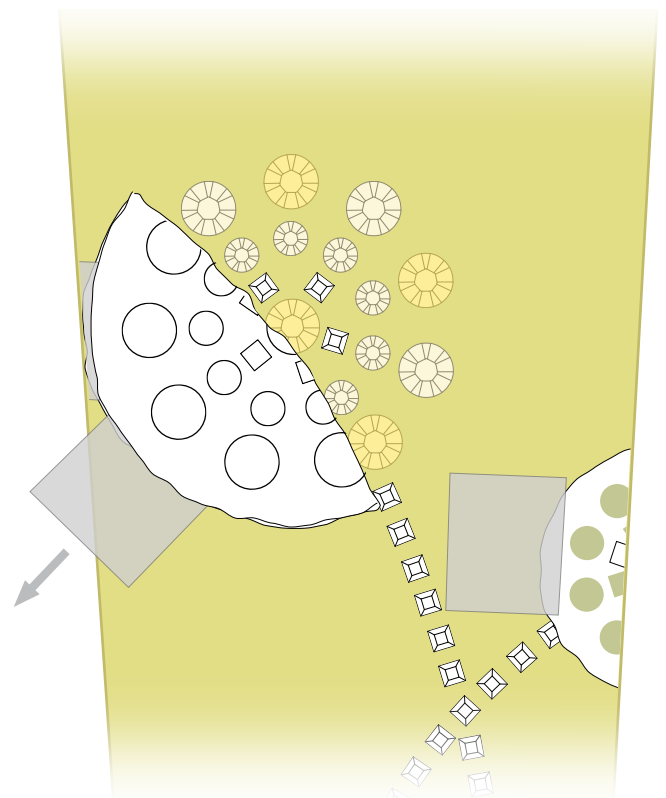
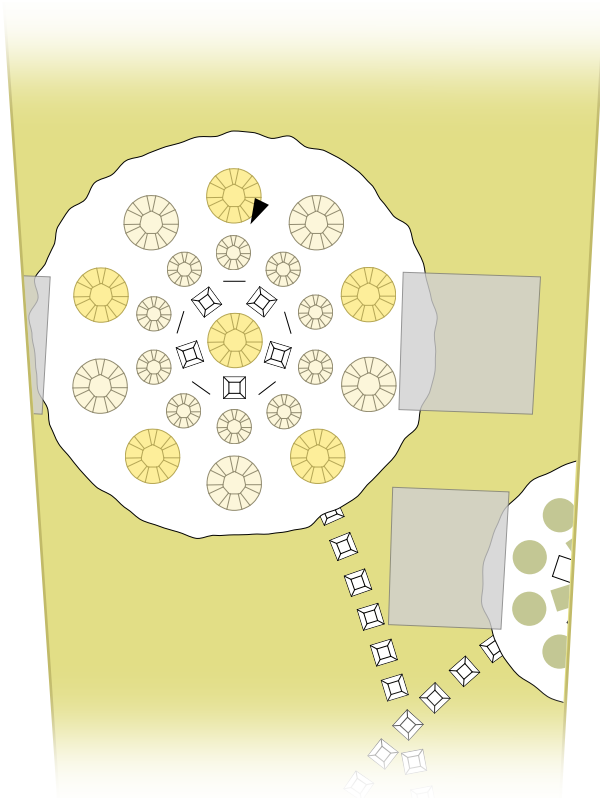

Repeat step 3 x26

1:1

STEP 8

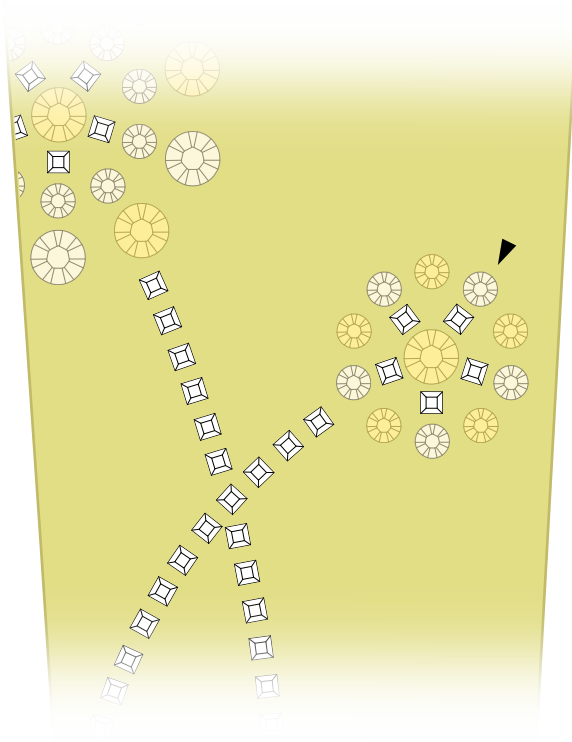

Repeat step 7

STEP 9

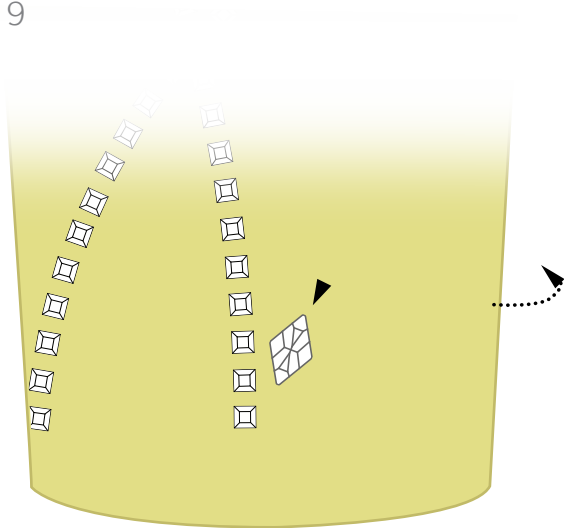

Repeat step 3 x3

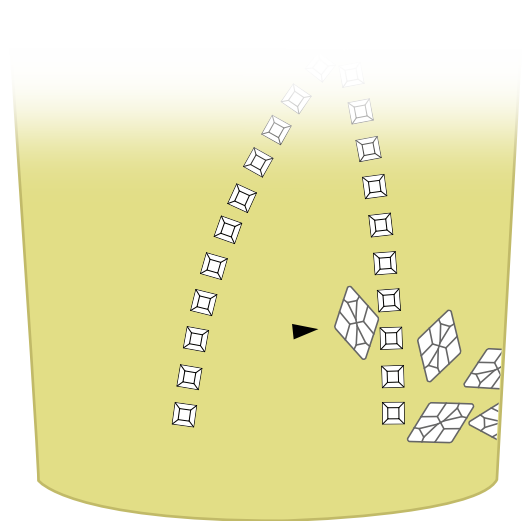

Repeat step 3 x8

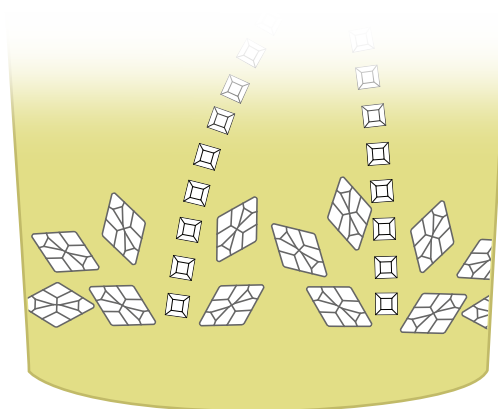

STEP 10

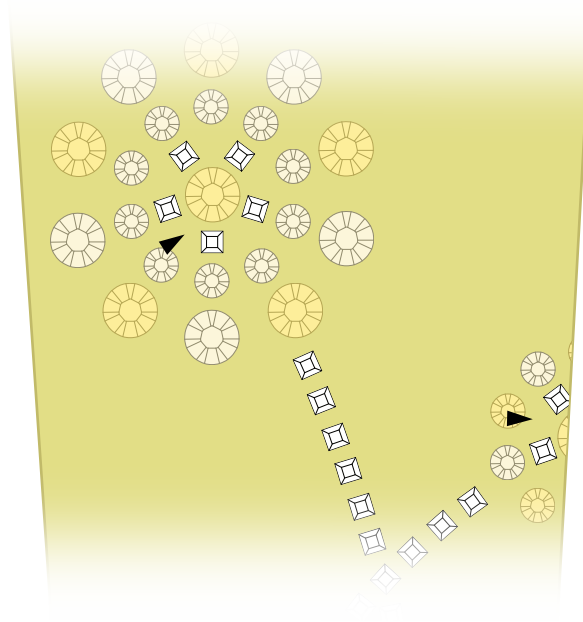

Repeat step 3 x9

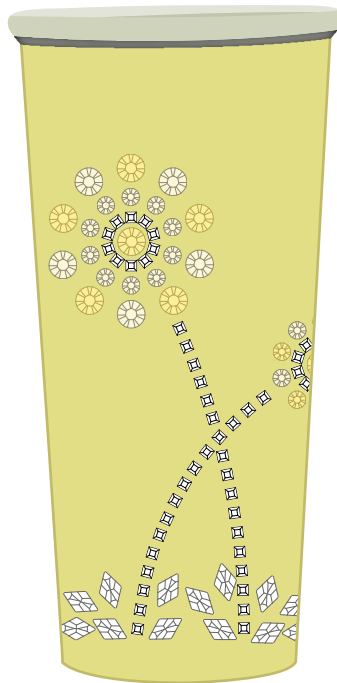

1:2

- Step 1: As seen in the illustration, form a flower pattern (Flower and stems) with flat backs on the piece of paper. Outline the crystal on the paper, remove the crystals and cut or punch holes in the paper according to the pattern, (the holes should be slightly bigger than crystals).
- Step 2: Tape flower stem patterns on the vase.
- Step 3: Apply glue on the back of the CRYSTALLIZED™ Flat Backs No Hotfix article 2400 and article 2028 SS 34 with a small stick or toothpick and then apply crystals in the respective holes of the pattern using tweezers. Gently press the crystals onto the vase.
- Step 4: Remove the paper pattern after glue is set.
- Step 5 – 6: Adjust pattern for flower shape and secure with tape.
- Step 7 – 8: First apply CRYSTALLIZED™ – Swarovski Elements in one flower and let the glue dry. Remove the pattern and apply the glue to the crystals for the second flower.
- Step 9: Apply the first group of Flat Backs No Hotfix article 2709 on one side of the vase and let dry. Repeat for other side of vase.
- Step 10: Repeat step 3 nine times to apply the rest of the remaining CRYSTALLIZED™ – Swarovski Elements on the vase as seen in the illustration.